

Y-110 – S-2 Glass® Yarn

S-2 Glass® yarns are typically used for further fabrication such as plying, winding, braiding, weaving, and serving.

General Product Specifications

Product Information

Product	SCD450	SCG75			SCG150	
Glass Type	S-2	S-2			S-2	
Filament Diameter - µm	5	9	9	9	9	9
Binder	636	950	636	933	950	636
Bobbin	7636	7636	7636	7636	7636	7636
Plies	1/0	1/0	1/0	1/0	1/0	1/0
Nominal Yield - yd/lb	45,000	7,500	7,295	7,500	15,000	14,659
Tex - g/1000 m	11.00	66.10	68.00	66.10	33.10	33.80
Tex Tolerance +/-	1.30	4.80	6.20	4.90	2.60	3.40
Nominal Solids - %	1.60	0.4	1.17	0.30	0.4	1.25
Solids Tolerance +/-	0.50	0.25	0.26	0.15	0.25	0.25
Nominal Twist - TPI (TPM)	1.0Z (Z40)	1.0Z (Z40)	1.0Z (Z40)	0.7Z (Z28)	1.0Z (Z40)	1.0Z (Z40)
Twist Tolerance +/- TPI (TPM)	0.30 (12)	0.30 (12)	0.30 (12)	0.21 (8)	0.30 (12)	0.30 (12)
Maximum Broken Filaments*	9	9	9	9	9	9
Minimum Tensile** - lb (N)	1.7 (7.6)	12.9 (57.4)	7.1 (31.6)	10.7 (47.6)	5.6 (24.9)	3.7 (16.5)

* Broken filaments based on average 360° count

** Average of 5 measurements per bobbin

Nominal Product Characteristics

(For reference only, not specified or controlled)

Average Bare Glass Tensile* - lb (N)	2.3 (10.2)	16.2 (72.1)	10.8 (48.0)	14.7 (65.4)	7.4 (32.9)	5.7 (25.4)
Approximate Yarn Diameter - in (mm)	0.0030 (0.076)	0.0076 (0.192)	0.0076 (0.192)	0.0076 (0.192)	0.0054 (0.136)	0.0054 (0.136)

* Average tensile per bobbin

Packaging Information

Bobbin	7636	7636	7636	7636	7636	7636
Nominal Bobbin Weight - lb (kg)	1.8 (0.82)	5.0 (2.27)	5.0 (2.27)	4.7 (2.13)	4.6 (2.09)	5.0 (2.27)
Minimum Bobbin Weight - lb (kg)	0.50 (0.23)	0.50 (0.23)	0.50 (0.23)	0.50 (0.23)	0.50 (0.23)	0.50 (0.23)
Metered Bobbin Length - yd (m)	88,000 (80,400)	37,500 (34,200)	36,000 (32,900)	36,000 (32,900)	N/A	68,000 (62,100)
Metered Ratio - %	60	70	60	70	N/A	60

Rev 20, 10.22.2020

Y-110 – S-2 Glass® Yarn

Nominal Packaging Dimensions

Bobbin	Pallet	Bobbins / Layer	Layers / Carton	Cartons / Pallet	Bobbins / Pallet	L-in (cm)	W-in (cm)	H-in (cm)
7636	Wood	18	3	4	216	45.5 (115.6)	45.5 (115.6)	45.5 (115.6)

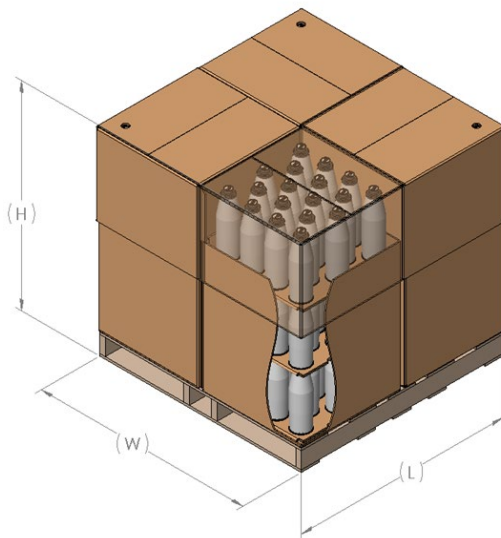

Storage, Shelf Life and Handling

Storage and Shelf Life:

AGY recommends storing the materials in accordance with appropriate safety considerations, away from exposure to the elements and at 65-80F (18-27C) and 50-70% humidity. If the materials are stored under these conditions, they are stable, non reactive and will not degrade or exhibit negative characteristics for at least 3 years from the date of manufacture. Unused, unopened product older than this is likely still in good condition, however careful evaluation is recommended. Prior to use, pallets should be placed in the production area and any plastic wrap removed for a minimum of 24 hours to allow the material to acclimate to the processing environment. Special care should be given to pallets being moved from a cold environment into a warm, humid area as condensation may occur and this additional moisture can negatively impact the runability of the material, however, once the material has acclimated, this will no longer be an issue.

For product traceability reasons, the pallet label should be recorded or retained.

Handling:

Fiberglass products process best if temperature and humidity are controlled, primarily because this will help to minimize the buildup of static electricity, fuzz and fly. AGY recommends that the material be run at 70 +/- 5 degrees F (18-27C) and 60 +/- 5% RH.

Test Methods and Certificates

A copy of test methods and or a certificate of conformity may be issued upon request.

Packages will be firmly and evenly wound on the bobbin, and free from defects in workmanship. AGY accepts no responsibility for damaged material that shows any signs of physical abuse.

For additional product information, refer to PTS M-710

AGY – World Headquarters / Americas

2556 Wagener Road
 Aiken, South Carolina, USA 29801
 Phone: +(1) 888.434.0945 (toll free)
 +(1) 803.643.1501
 Fax: +(1) 803.643.1180
 Email: asktheexpert@agy.com

AGY – Europe

Le Gemellyon Nord
 57 Boulevard Marius Vivier Merle
 69003 Lyon, France
 Phone: +(33) 4727 81775
 Fax: +(33) 4727 81780